



JOC827 Series

Rev.A.1.0

DESCRIPTION:

The JOC827 series provide two channel operation, and each combines an AlGaAs infrared emitting diode as the emitter which is optically coupled to a silicon planar phototransistor detector in a plastic DIP8 package with different lead forming options. With the robust coplanar double mold structure, JOC827 provides the most stable isolation feature. The products are widely used in computer peripheral interface and microprocessor system interface.

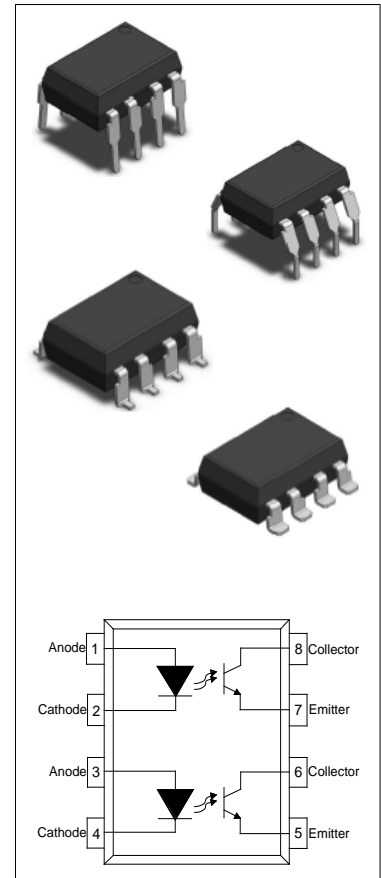

MAIN FEATURES

- High isolation 5000 VRMS
- DC input with transistor output
- Operating temperature range -55°C to +110°C
- REACH compliance
- Halogen free (Optional)
- CQC approved
- VDE approved
- UL approved

ABSOLUTE MAXIMUM RATINGS (Temperature=25°C)

Parameter		Symbol	Value	Unit
Input	Forward Current	I_F	60	mA
	Peak Forward Current	I_{FP}	1 ^①	A
	Reverse Voltage	V_R	6	V
	Power Dissipation	P_D	100	mW
Output	Collector-emitter Voltage	V_{CEO}	35	V
	Emitter-collector Voltage	V_{ECO}	6	V
	Collector Current	I_C	50	mA
	Power Dissipation	P_C	150	mW
Total Power Dissipation		P_{tot}	200	mW
Isolation Voltage		V_{iso}	5000 ^②	Vrms
Operating Temperature		T_{opr}	-55~+110	°C

Storage Temperature	T_{stg}	-55~+125	°C
Soldering Temperature	T_{sol}	260	°C

NOTE1: 100 μ s pulse, 100Hz frequency

NOTE2: AC for 1minute, R.H.=40~60%

ELECTRICAL CHARACTERISTICS (Temperature=25°C)

Parameter		Symbol	Condition	Min.	Typ.	Max.	Unit
Input	Forward Voltage	V_F	$I_F=10mA$	-	1.2	1.3	V
			$I_F=20mA$	-	1.24	1.4	
	Reverse Current	I_R	$V_R=6V$	-	-	1	μA
	Terminal Capacitance	C_t	$V=0,$ $f=1MHz$	-	30	250	pF
Output	Collector-Emitter dark current	I_{CEO}	$V_{CE}=20V,$ $I_F=0$	-	-	50	nA
	Collector-Emitter breakdown voltage	BV_{CEO}	$I_C=0.1mA$ $I_F=0$	35	-	-	V
	Emitter-Collector breakdown voltage	BV_{ECO}	$I_E=0.1mA$ $I_F=0$	6	-	-	V
Transfer Characteristics	Current transfer ratio	CTR	$I_F=5mA$ $V_{CE}=5V$	130	-	400	%
	Collector-Emitter Saturation Voltage	$V_{CE(sat)}$	$I_F=20mA$ $I_C=1mA$	-	0.06	0.2	V
	Isolation resistance	R_{IO}	DC500V 40~60%R.H.	5×10^{10}	10^{11}	-	Ω
	Floating Capacitance	C_{IO}	$V=0,$ $f=1MHz$	-	0.4	1	pF
	Cut-off Frequency	f_c	$V_{CE}=5V,$ $I_C=2mA$ $R_L=100\Omega,$ -3dB	-	80	-	kHz
	Rise Time	t_r	$V_{CE}=2V,$ $I_C=2mA$ $R_L=100\Omega$	-	5	18	μs
	Fall Time	t_f		-	4	18	μs
Response Time	t_{on}	-		9	25	μs	
	t_{off}	-		5	25	μs	

ORDERING AND MARKING INFORMATION

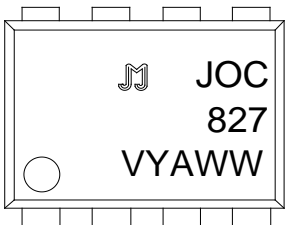
MARKING INFORMATION			
		JOC : Company Abbr. 827 : Part Number VYAWW : LOT NO.	
ORDERING INFORMATION			
JOC827(Y)(Z)- GV			
JOC – Company Abbr. 827 – Part Number Y – Lead Form Option (M/S/SL/None) Z – Tape and Reel Option (T1/T2) G – Green V – VDE Option (V or None)			
Packing Quantity			
Option	Quantity	Quantity – Inner box	Quantity –Outer box
None/M	45 Units/Tube	32 Tubes/Inner box	10 Inner box/Outer box =14.4k Units
S(T1/T2)	1000 Units/Reel	3 Reels/Inner box	5 Inner box/Outer box =15k Units
SL(T1/T2)	1000 Units/Reel	3 Reels/Inner box	5 Inner box/Outer box =15k Units

Characteristics Curves

FIG.1: Forward Current vs. Ambient Temperature

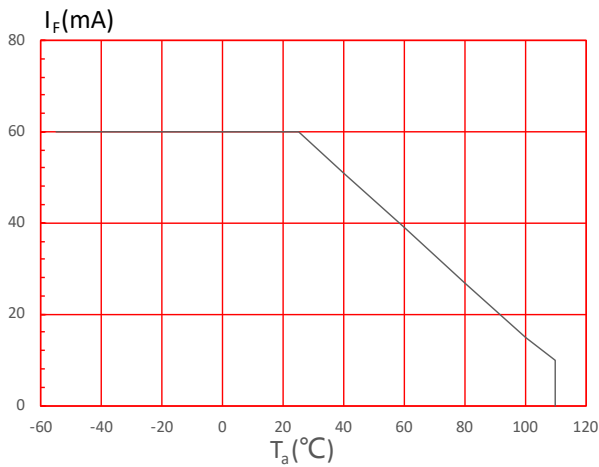

FIG.2: Collector Power Dissipation vs. Ambient Temperature

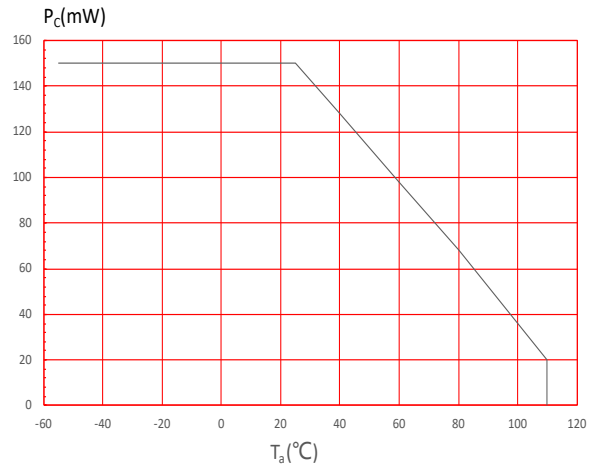

FIG.3: Forward Current vs. Forward Voltage

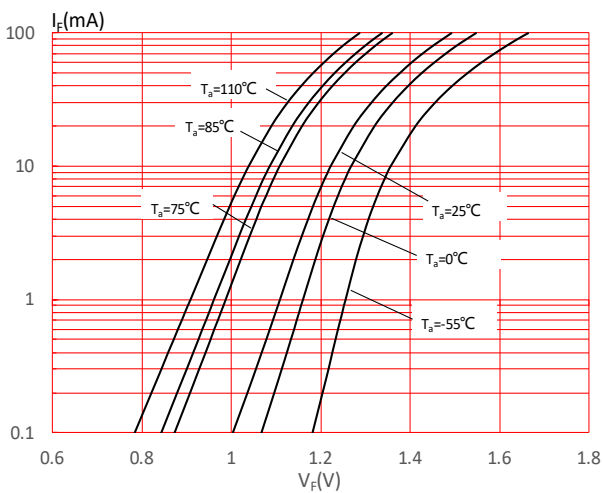

FIG.4: Normalized Collector Dark Current vs. Ambient Temperature

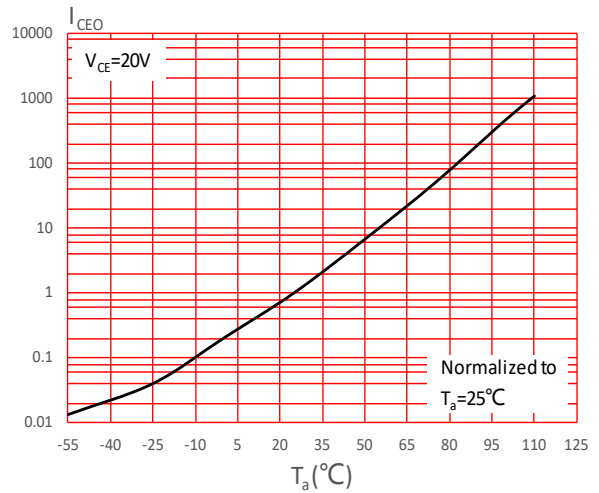

FIG.5: Collector Current vs. Collector-emitter Voltage

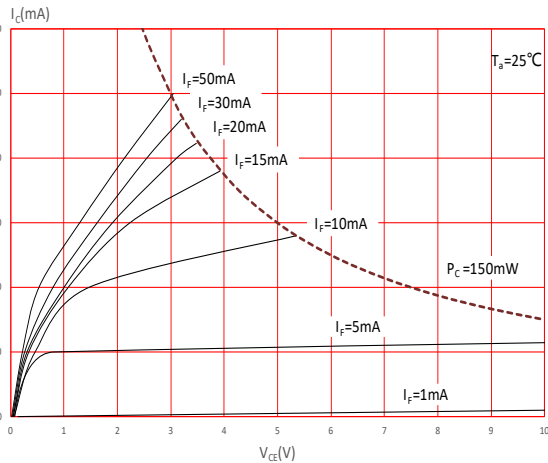

FIG.6: Normalized Current Transfer Ratio vs. Forward Current

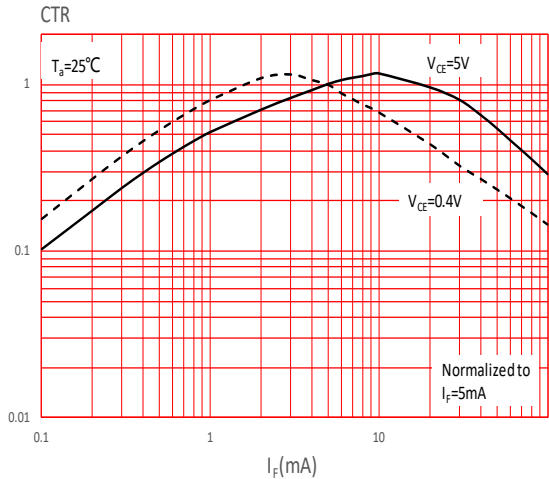

FIG.7: Normalized Current Transfer Ratio vs. Ambient Temperature

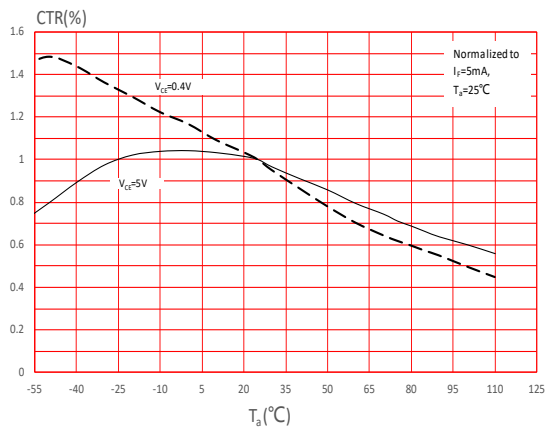

FIG.8: Normalized Collector-emitter Saturation Voltage vs. Ambient Temperature

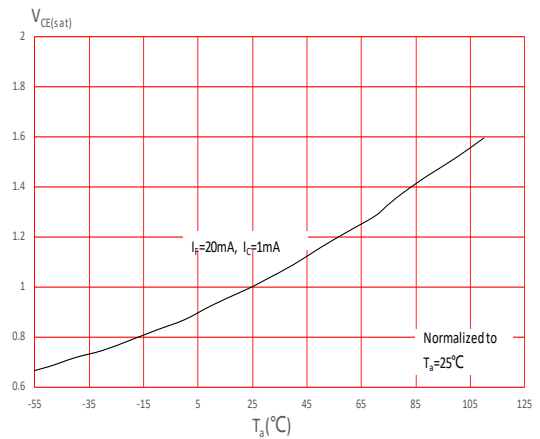

FIG.9: Response Time vs. Load Resistance

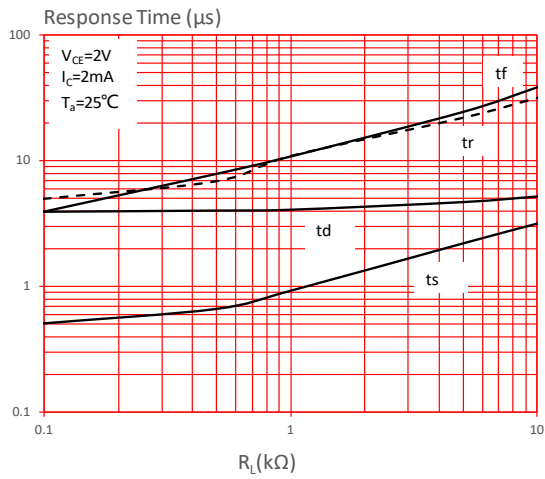
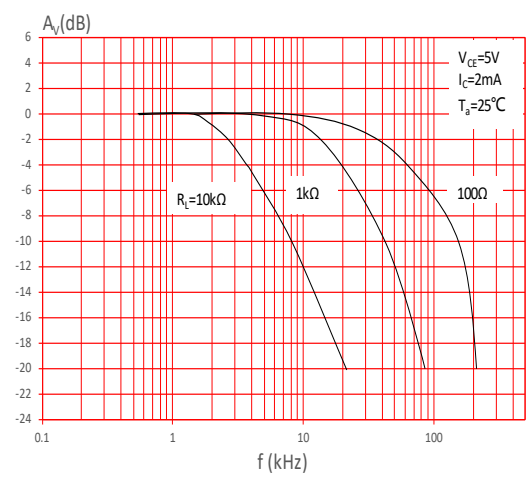

FIG.10: Frequency Response



Test Circuits

FIG.11: Test Circuits of Response Time

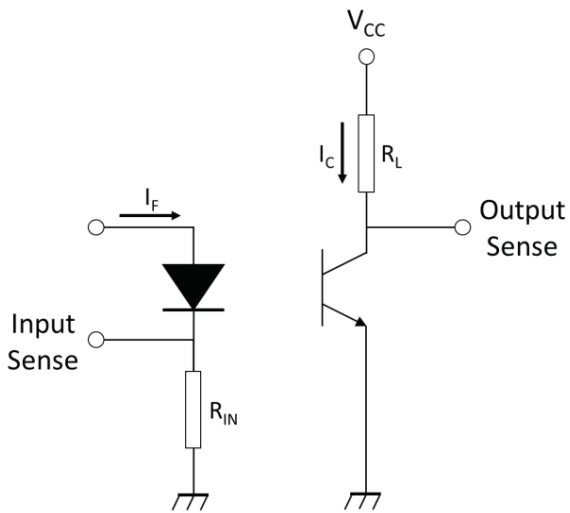

FIG.12: Curves of Response Time

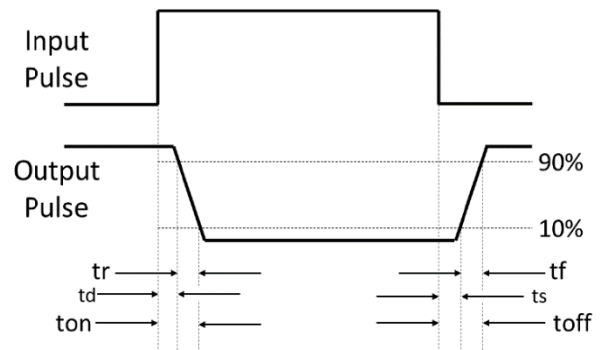
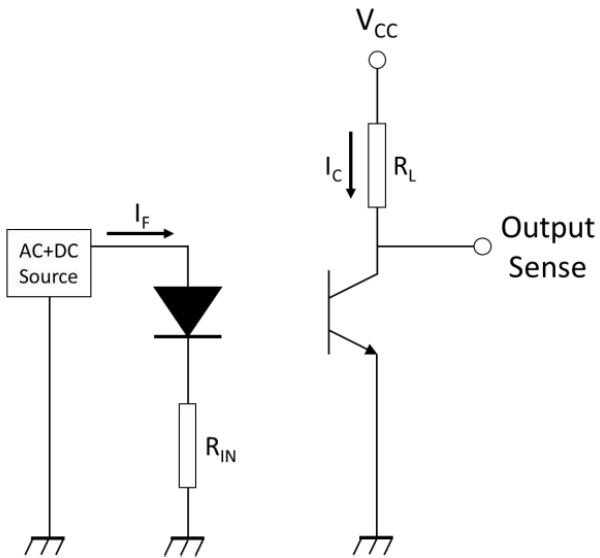
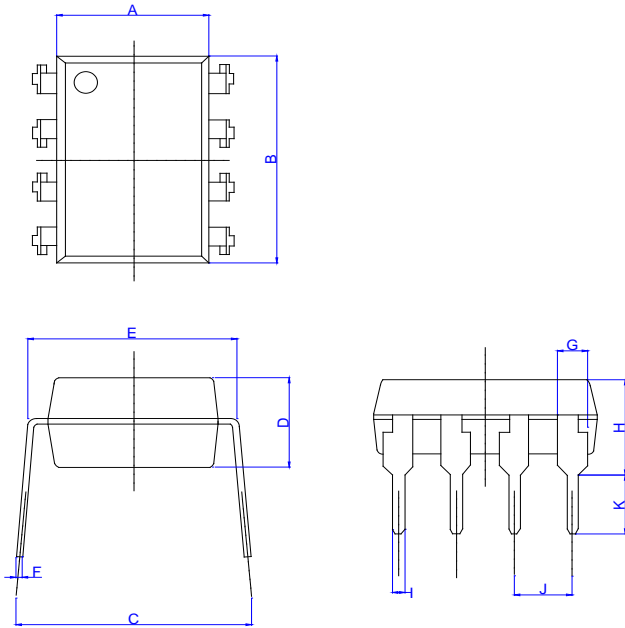

FIG.13: Test Circuits of Frequency Response



Package Dimension (Unit: mm)

Standard DIP Type:



Ref.	Dimensions					
	Millimeters			Inches		
	Min.	Typ.	Max.	Min.	Typ.	Max.
A	6.20		6.80	0.244		0.268
B	9.36		9.96	0.369		0.392
C	7.62		10.16	0.300		0.400
D	3.00		4.00	0.118		0.157
E	7.32		7.92	0.288		0.312
F	0.16		0.36	0.006		0.014
G	0.90		1.50	0.035		0.059
H	3.50		4.80	0.138		0.189
I	0.40		0.60	0.016		0.024
J	2.29		2.79	0.090		0.110
K	2.40		3.40	0.094		0.134

Option M Type:

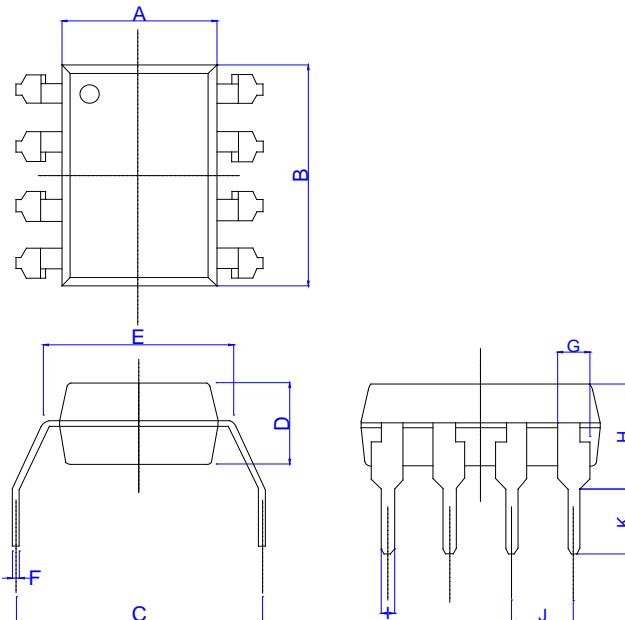

Ref.	Dimensions					
	Millimeters			Inches		
	Min.	Typ.	Max.	Min.	Typ.	Max.
A	6.40		6.80	0.252		0.268
B	9.56		9.96	0.376		0.392
C	9.86		10.46	0.388		0.412
D	3.30		3.70	0.130		0.146
E	7.32		7.92	0.288		0.312
F		0.25			0.010	
G	1.20		1.40	0.047		0.055
H	4.28		4.88	0.169		0.192
I		0.50			0.020	
J		2.54			0.100	
K		2.20			0.087	

Option S Type:

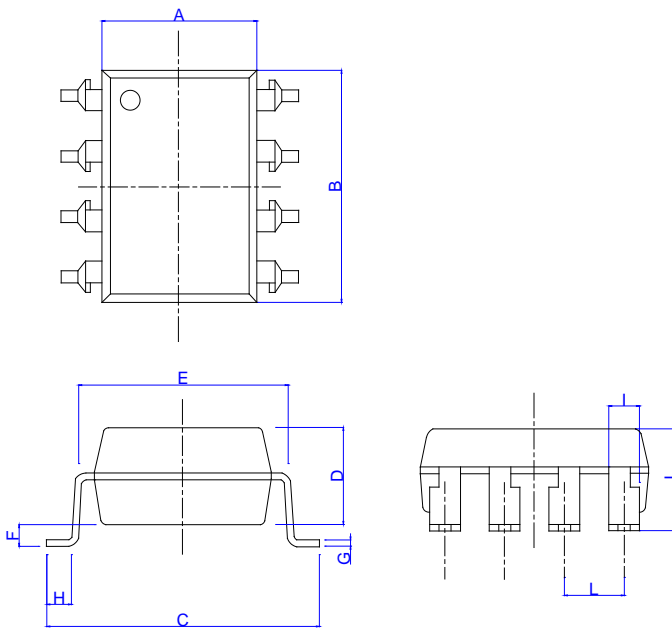

Ref.	Dimensions					
	Millimeters			Inches		
	Min.	Typ.	Max.	Min.	Typ.	Max.
A	6.40		6.80	0.252		0.268
B	9.56		9.96	0.376		0.392
C	9.85		10.45	0.388		0.412
D	3.30		3.70	0.130		0.146
E	7.32		7.92	0.288		0.312
F		0.80			0.031	
G		0.25			0.010	
H		0.80			0.031	
I	1.20		1.40	0.047		0.055
J	4.00		4.60	0.157		0.181
L		2.54			0.100	

Option SL Type:

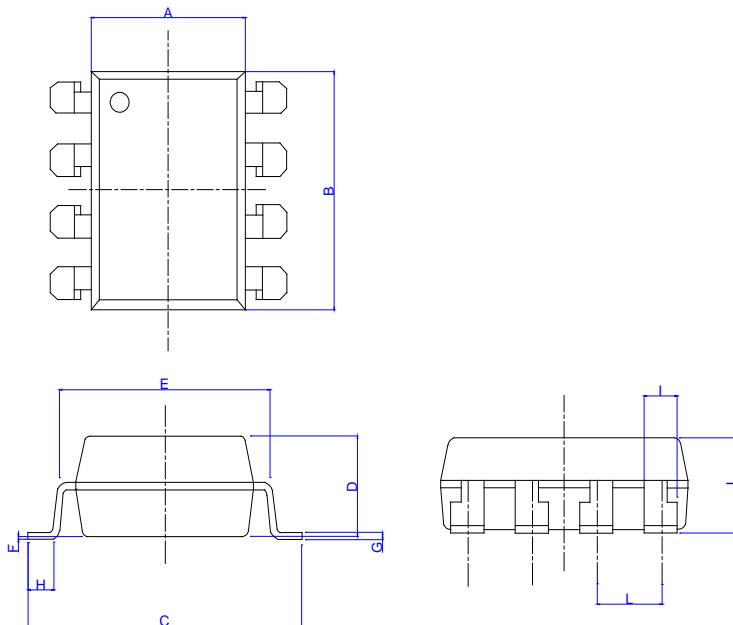

Ref.	Dimensions					
	Millimeters			Inches		
	Min.	Typ.	Max.	Min.	Typ.	Max.
A	6.20		6.80	0.244		0.268
B	9.36		9.96	0.369		0.392
C	9.50		10.45	0.374		0.411
D	3.00		4.00	0.118		0.157
E	7.32		7.92	0.288		0.312
F	0.10		0.65	0.004		0.026
G	0.16		0.36	0.006		0.014
H	0.80		1.40	0.031		0.055
I	0.90		1.50	0.035		0.059
J	3.30		4.35	0.130		0.171
L	2.29		2.79	0.090		0.110

RECOMMENDED SOLDER MASK (Dimensions in mm unless otherwise stated)

Option S

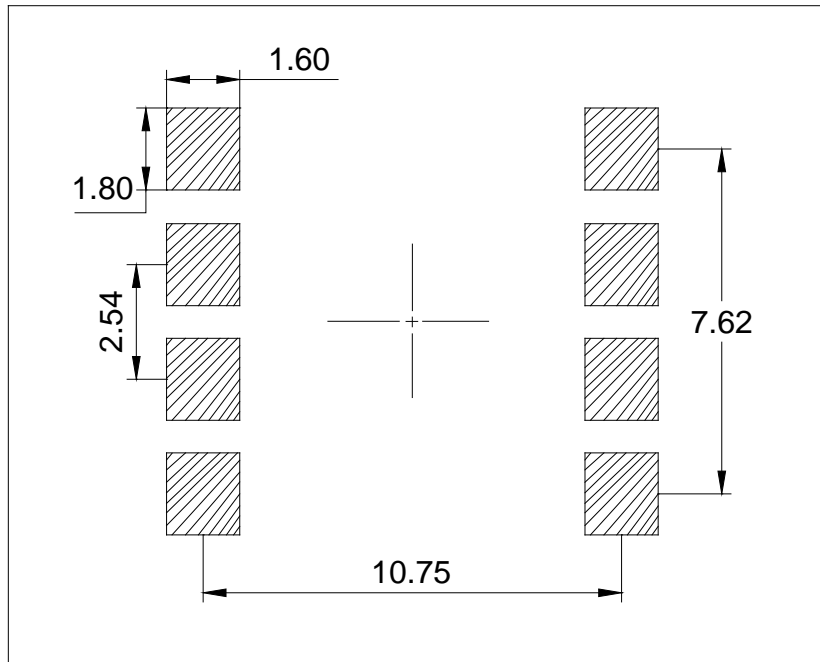

Option SL

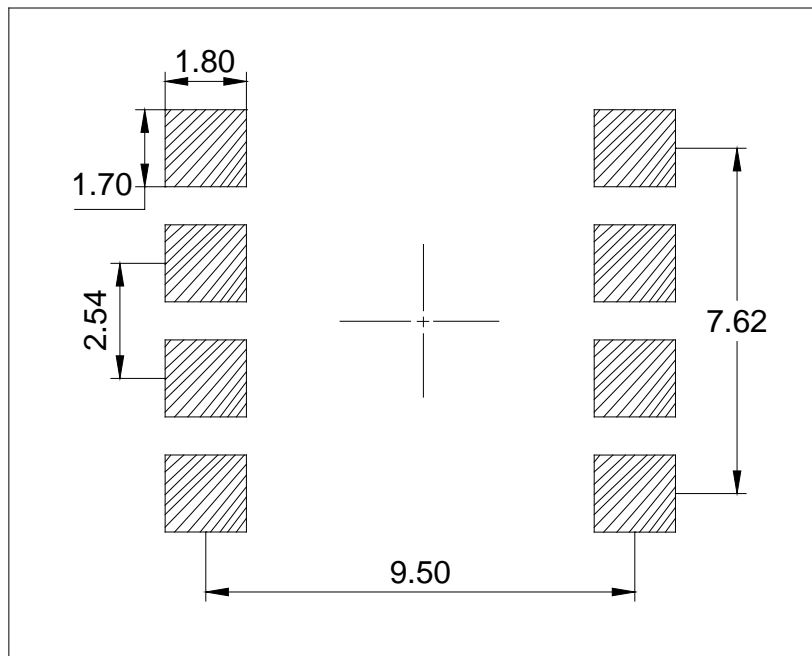

TUBE SPECIFICATIONS (Dimensions in mm unless otherwise stated)

Standard DIP

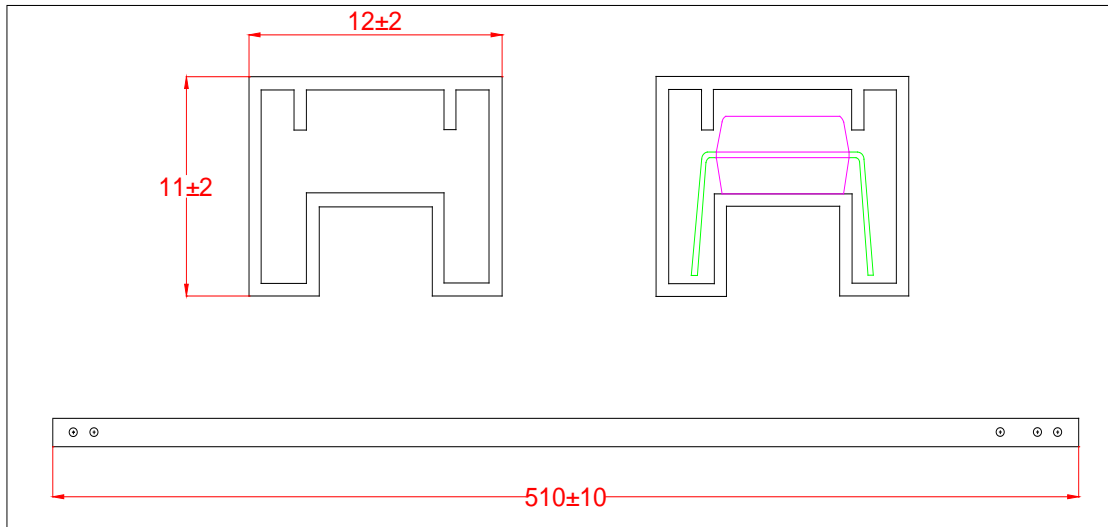

Option M

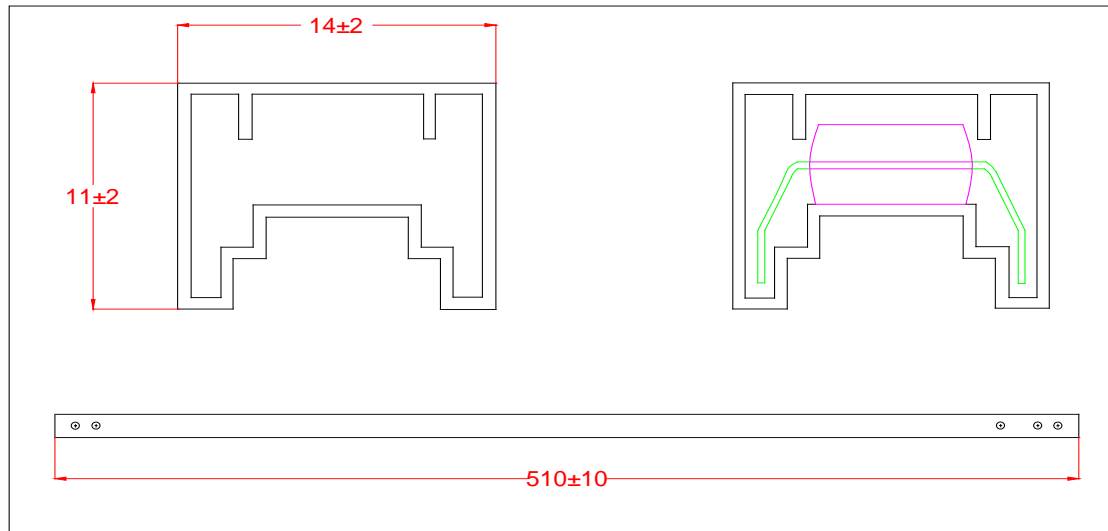

CARRIER TAPE SPECIFICATIONS (Dimensions in mm unless otherwise stated)

Option S(T1)

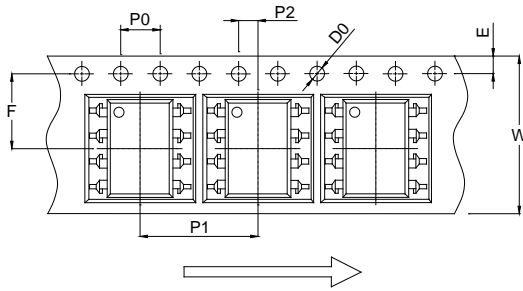

Ref.	Dimensions					
	Millimeters			Inches		
	Min.	Typ.	Max.	Min.	Typ.	Max.
D0		1.50	1.65		0.059	0.065
P0	3.90	4.00	4.10	0.154	0.157	0.161
P1	11.90	12.00	12.10	0.469	0.472	0.476
P2	1.90	2.00	2.10	0.075	0.079	0.083
E	1.65	1.75	1.85	0.065	0.069	0.073
F	7.40	7.50	7.60	0.291	0.295	0.299
T	0.35	0.40	0.45	0.014	0.016	0.018
W	15.70	16.00	16.30	0.618	0.630	0.642

Option S(T2)

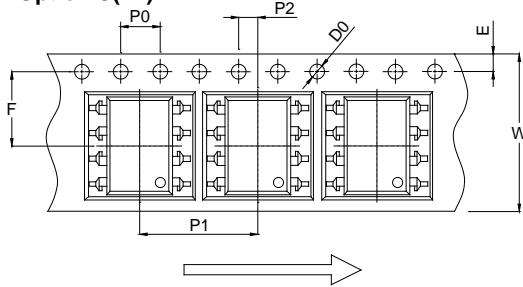

Option SL(T1)

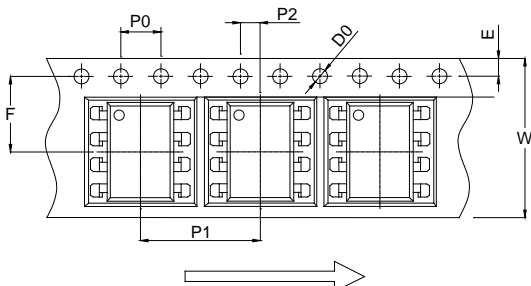

Ref.	Dimensions					
	Millimeters			Inches		
	Min.	Typ.	Max.	Min.	Typ.	Max.
D0		1.50	1.60		0.059	0.063
P0	3.90	4.00	4.10	0.154	0.157	0.161
P1	11.90	12.00	12.10	0.469	0.472	0.476
P2	1.90	2.00	2.10	0.075	0.079	0.083
E	1.65	1.75	1.85	0.065	0.069	0.073
F	7.40	7.50	7.60	0.291	0.295	0.299
T	0.35	0.40	0.45	0.014	0.016	0.018
W	15.70	16.00	16.30	0.618	0.630	0.642

Option SL(T2)

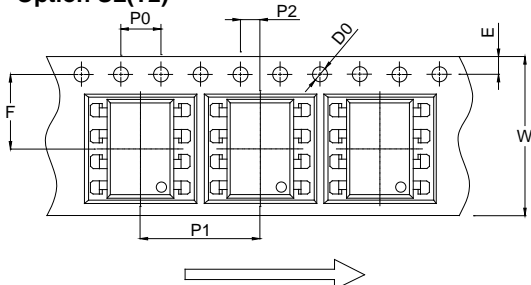

REFLOW INFORMATION

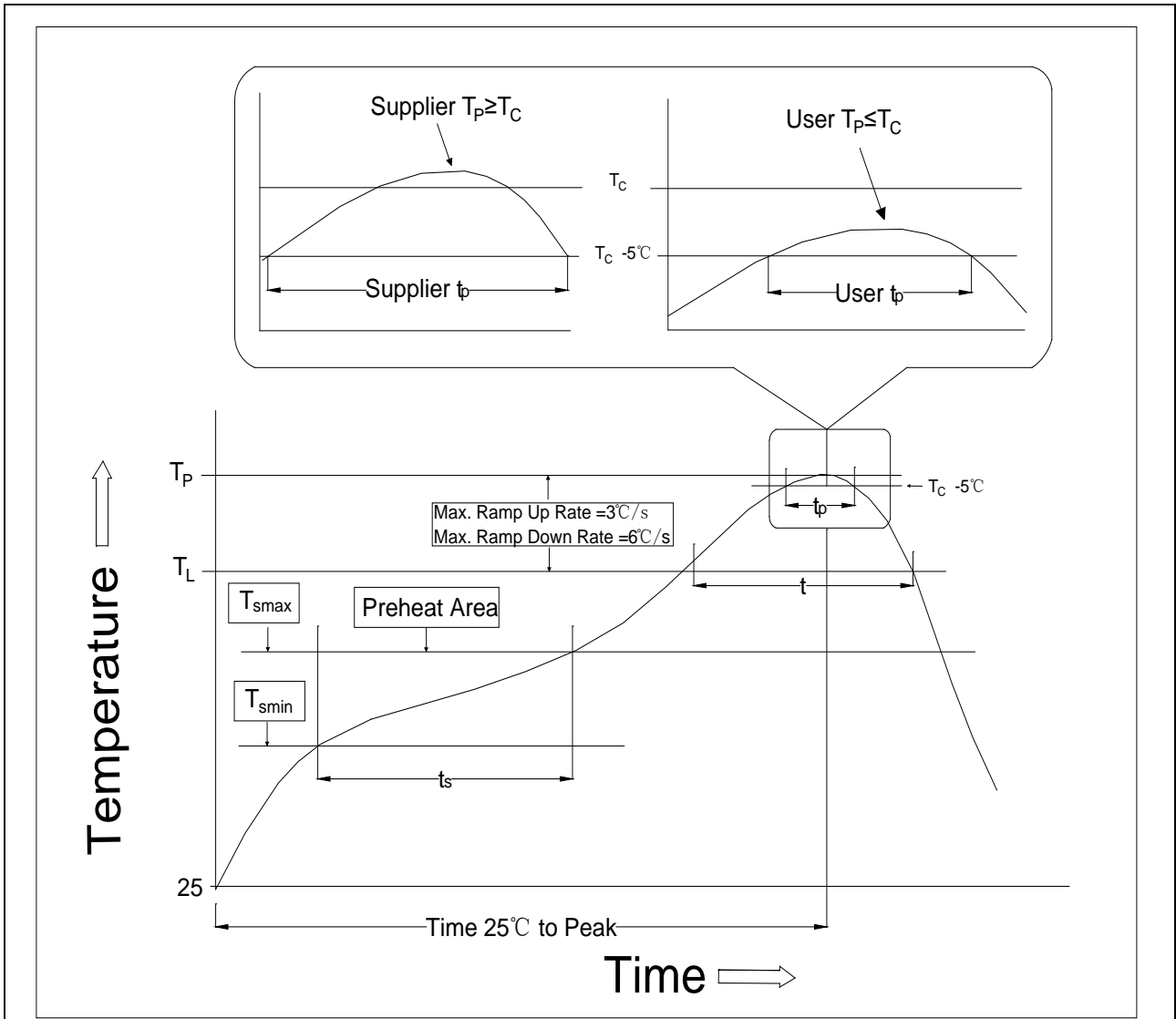

Profile Feature	Sn-Pb Assembly Profile	Pb-Free Assembly Profile
Temperature Min. (T _{smin})	100	150°C
Temperature Max. (T _{smax})	150	200°C
Time (t _s) from (T _{smin} to T _{smax})	60-120 seconds	60-120 seconds
Ramp-up Rate (t _L to t _P)	3°C/second max.	3°C/second max.
Liquidus Temperature (T _L)	183°C	217°C
Time (t _L) Maintained Above (T _L)	60-150 seconds	60-150 seconds
Peak Body Package Temperature	235°C+0°C/-5°C	260°C+0°C/-5°C
Time (t _P) within 5°C of 260°C	20 seconds	30 seconds
Ramp-down Rate (T _P to T _L)	6°C/second max.	6°C/second max.
Time 25°C to Peak Temperature	6 minutes max.	8 minutes max.

WAVE SOLDERING

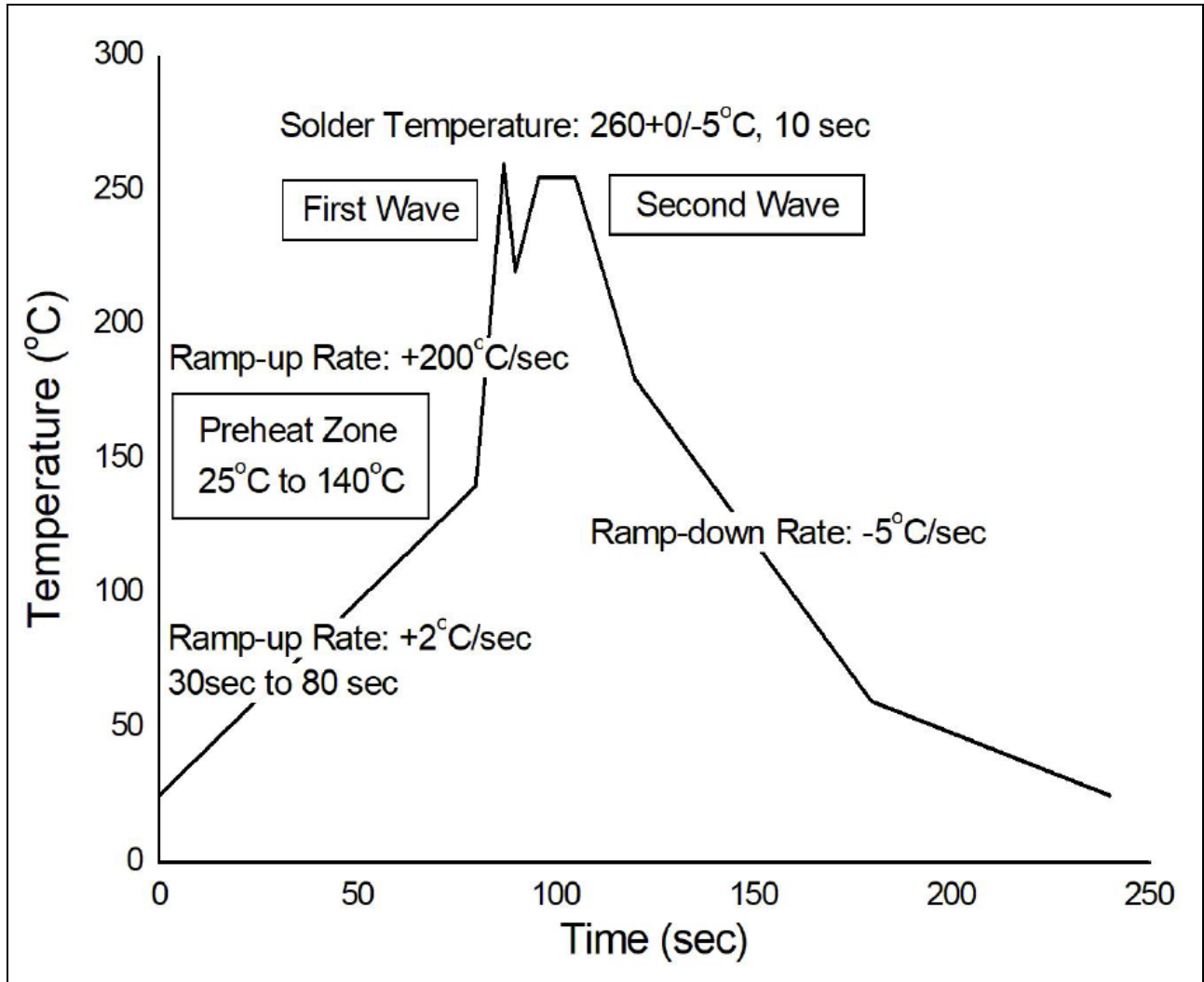

HAND SOLDERING BY SOLDERING IRON

Soldering Temperature	360±5°C
Soldering Time	3s max.

Information furnished in this document is believed to be accurate and reliable. However, Jiangsu JieJie Microelectronics Co., Ltd. assumes no responsibility for the consequences of use without consideration for such information nor use beyond it. Information mentioned in this document is subject to change without notice, apart from that when an agreement is signed, Jiangsu JieJie complies with the agreement.

Products and information provided in this document have no infringement of patents. Jiangsu JieJie assumes no responsibility for any infringement of other rights of third parties which may result from the use of such products and information. This document supersedes and replaces all information previously supplied.

 is a registered trademark of Jiangsu JieJie Microelectronics Co., Ltd.
Copyright © 2025 Jiangsu JieJie Microelectronics Co., Ltd. All rights reserved.