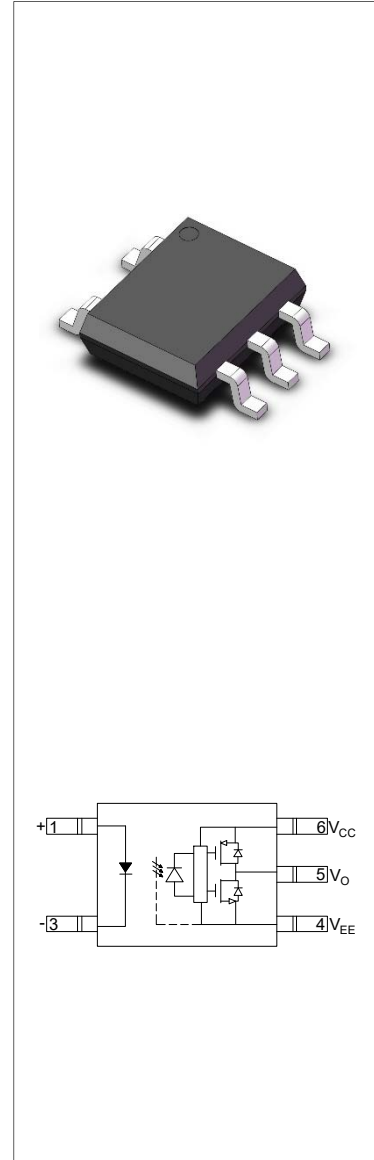


### DESCRIPTION:

The products are gate driver opto-couplers in the SOP5 package. The device consists of an infrared LED optically coupled to an integrated high-gain, high-speed photodetector IC chip. It provides guaranteed performance and specifications at temperature up to 110°C. It is physically smaller and compliant with international safety standards for reinforced insulation. It thus provides a smaller footprint solution for applications that require safety standard certification. An internal noise shield provides a guaranteed common-mode transient immunity of  $\pm 35 \text{ kV}/\mu\text{s}$ . It is ideal for small class IGBT and power MOSFET gate drive. The products are widely used in industrial inverters, IGBT gate drivers, MOSFET gate drivers, induction cooktop and home appliances.



### MAIN FEATURES

- 3A maximum peak output current
- High isolation 3750 VRMS
- Buffer logic type
- Operating temperature range -40°C to 110°C
- REACH & RoHS compliance
- HBM: H3A; MM: M4; CDM: C3
- CQC approved
- VDE approved
- UL approved

### Truth Table

LED	V <sub>CC</sub> -V <sub>EE</sub> (Positive Going)	V <sub>CC</sub> -V <sub>EE</sub> (Negative Going)	Output
OFF	0-30V	0-30V	Low
ON	0-6.9V	0-5.9V	Low
ON	6.9V-8.7V	5.9V-7.5V	TRANSITION
ON	8.7V-30V	7.5V-30V	HIGHT

**ABSOLUTE MAXIMUM RATINGS** (Temperature=25°C)

Parameter		Symbol	Value	Unit
LED	Forward Current	$I_F$	50	mA
	Peak Forward Current	$I_{FP}$	1 <sup>①</sup>	A
	Reverse Voltage	$V_R$	6	V
	Power Dissipation	$P_D$	100	mW
Detector	Output Voltage	$V_O$	35	V
	Supply Voltage	$V_{CC}$	35	V
	Power Dissipation	$P_C$	400	mW
Isolation Voltage		$V_{iso}$	3750 <sup>②</sup>	Vrms
Operating Temperature		$T_{opr}$	-40~110	°C
Junction Temperature		$T_j$	125	°C
Storage Temperature		$T_{stg}$	-55~125	°C
Total Power Dissipation		$P_{tot}$	500	mW
Soldering Temperature		$T_{sol}$	260	°C

**NOTE1** : 100μs pulse, 100Hz frequency

**NOTE2** : AC for 1minute, R.H.=40~60%

**ELECTRICAL CHARACTERISTICS** (Temperature=25°C)

Parameter		Symbol	Condition	Min.	Typ.	Max.	Unit
Input	Forward Voltage	$V_F$	$I_F=10mA$	-	1.35	1.6	V
	Reverse Current	$I_R$	$V_R=6V$	-	-	1	μA
	Terminal Capacitance	$C_t$	$V=0, f=1MHz$	-	60	-	pF
Output	Peak High-level Output Current	$I_{OPH}$	$V_O=V_{CC}-4V,$ Pulse width≤50μs	-1	-	-	A
			$V_O=V_{CC}-15V,$ Pulse width≤10μs	-3	-	-	A
	Peak Low-level Output Current	$I_{OPL}$	$V_O=V_{EE}+2.5V,$ Pulse width≤50μs	1	-	-	A
			$V_O=V_{EE}+15V,$ Pulse width≤10μs	3	-	-	A
	High Level Supply Current	$I_{CCH}$	$I_F=10mA$ $V_{CC}=30V,$ $V_O=Open,$	-	1.2	2	mA
	Low Level Supply Current	$I_{CCL}$	$I_F=0mA,$ $V_{CC}=30V,$ $V_O=Open,$	-	1.1	2	mA

High Level Output Voltage	$V_{OH}$	$I_F=5mA,$ $V_{CC}=10V,$ $I_O=-100mA$	6	8.4	-	V
Low Level Output Voltage	$V_{OL}$	$V_F=0.8V,$ $V_{CC}=10V,$ $I_O=100mA$	-	0.3	1	V
Threshold Input Current	$I_{FLH}$	$V_{CC}=15V,$ $V_O>1V$	-	1.2	5	mA
Threshold Input Voltage	$V_{FHL}$	$V_{CC}=15V,$ $V_O<1V$	0.8	-	-	V
Supply Voltage	$V_{CC}$	-	10	-	30	V
UVLO Threshold	VUVLO+	$V_O>2.5V,$ $I_F=5mA$	7.5	8.7	9.5	V
	VUVLO-	$V_O<2.5V,$ $I_F=5mA$	7.5	8.4	9.5	V

**SWITCHING SPECIFICATION**

Parameter	Symbol	Condition	Min.	Typ.	Max.	Unit
Propagation Delay Time to High Output Level	$t_{PLH}^{①}$	$R_g=47\Omega$ , $C_g=3nF$ , $I_F=0\rightarrow 5mA$ , $V_{CC}=30V$	30	-	500	ns
Propagation Delay Time to Low Output Level	$t_{PHL}^{①}$	$R_g=47\Omega$ , $C_g=3nF$ , $I_F=5\rightarrow 0mA$ , $V_{CC}=30V$	30	-	500	
Propagation Delay Difference Between Any Two Parts	$t_{PHL} - t_{PLH}^{①}$	$R_g=47\Omega$ , $C_g=3nF$ , $I_F=0\leftarrow\rightarrow 5mA$ , $V_{CC}=30V$	-	-	350	
Output Rise Time (10 to 90%)	$t_r^{①}$	$R_g=47\Omega$ , $C_g=3nF$ , $I_F=0\rightarrow 5mA$ , $V_{CC}=30V$	-	50	-	
Output Fall Time (90 to 10%)	$t_f^{①}$	$R_g=47\Omega$ , $C_g=3nF$ , $I_F=5\rightarrow 0mA$ , $V_{CC}=30V$	-	50	-	
Common Mode Transient Immunity at High Level Output	$ CM_H ^{②}$	$I_F=5mA$ $V_{CC}=30V$ , $T_a=25^\circ C$ , $V_O(\min)=26V$ $V_{CM}=1000V_{pp}$	$\pm 35$	-	-	
Common Mode Transient Immunity at Low Level Output	$ CM_L ^{③}$	$I_F=0mA$ $V_{CC}=30V$ , $T_a=25^\circ C$ , $V_O(\max)=1V$ $V_{CM}=1000V_{pp}$	$\pm 35$	-	-	kV/ $\mu s$

All Typical values at  $T_a=25^\circ C$

**Note1:** Input signal ( $f=25kHz$ ,  $duty=50\%$ ,  $t_r=t_f=5ns$  or less).  $C_L$  is less than 15 pF which includes probe and stray wiring capacitance.

**Note2:**  $CM_H$  is the maximum rate of fall of the common mode voltage that can be sustained with the output voltage in the logic high state ( $V_O > 26V$ ).

**Note3:**  $CM_L$  is the maximum rate of rise of the common mode voltage that can be sustained with the output voltage in the logic low state ( $V_O < 1V$ ).

Recommended Operating Conditions<sup>①②</sup>

Characteristics	Symbol	Min.	Typ.	Max.	Unit
Input On-state Current	$I_{F(ON)}^{③}$	6.5	-	10	mA
Input Off-state Voltage	$V_{F(OFF)}$	0	-	0.8	V
Supply Voltage	$V_{CC}^{④}$	10	-	30	V
Operating Frequency	$f^{⑤}$	-	-	25	kHz

**Note1:** The recommended operating conditions are given as a design guide necessary to obtain the intended performance of the device. Each parameter is an independent value. When creating a system design using this device, the electrical characteristics specified in this datasheet should also be considered.

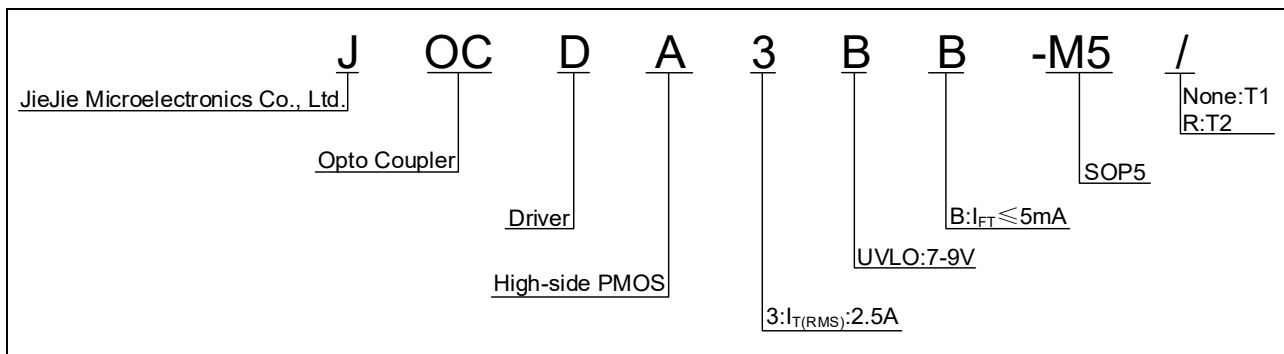
**Note2:** A ceramic capacitor(0.1μF) should be connected between pin 6 ( $V_{CC}$ ) and pin 4 (GND) to stabilize the operation of a high-gain linear amplifier. Otherwise, this photocoupler may not switch properly. The bypass capacitor should be placed within 1 cm of each pin.

**Note3:** The rise and fall times of the input on-current should be less than 0.5 μs.

**Note4:** If the rising slope of the supply voltage ( $V_{CC}$ ) for the detector is steep, stable operation of the internal circuits cannot be guaranteed. Be sure to set 3 V/μs or less for a rising slope of the  $V_{CC}$ .

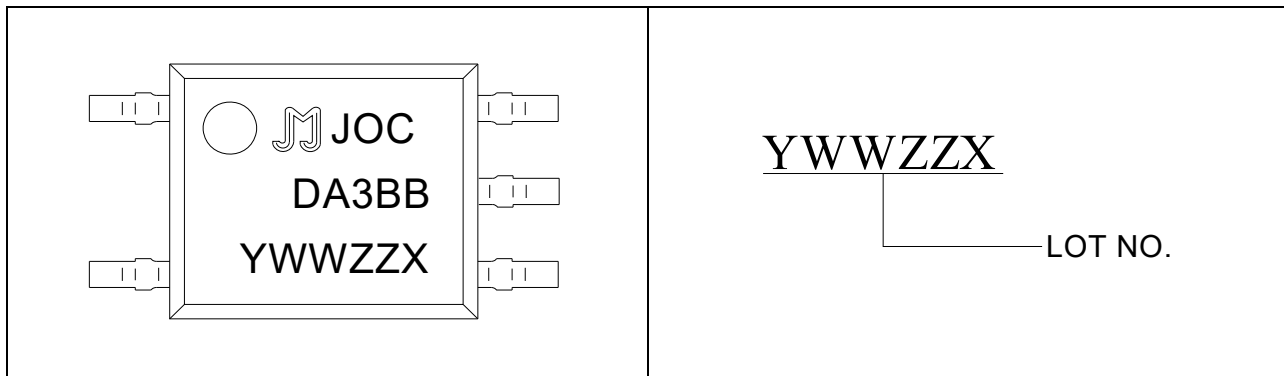
**Note5:** Denotes the operating range, not the recommended operating condition.

**ORDERING INFORMATION**



Packing Quantity	
Option	Quantity
None/R	3000 Units/Reel

**MARKING**



Characteristics Curves

FIG.1: Forward Current vs. Forward Voltage

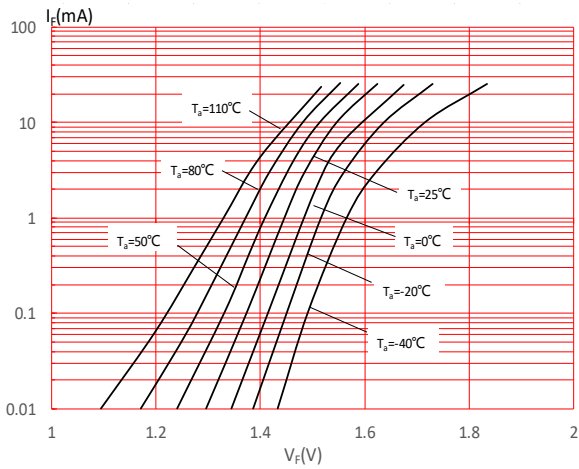


FIG.2: Max. Allowable LED Forward Current vs. Ambient Temperature

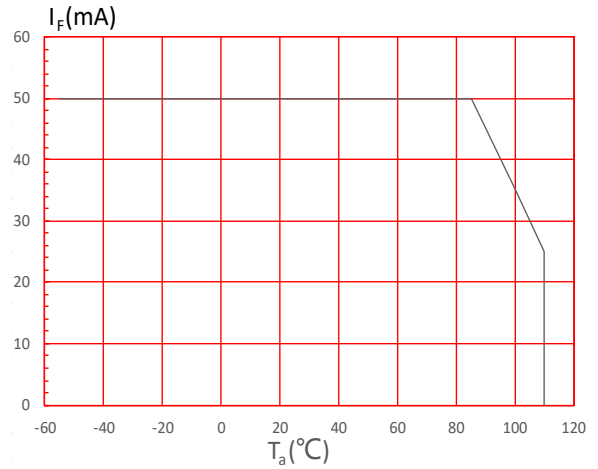


FIG.3: Collector Power Dissipation vs. Ambient Temperature

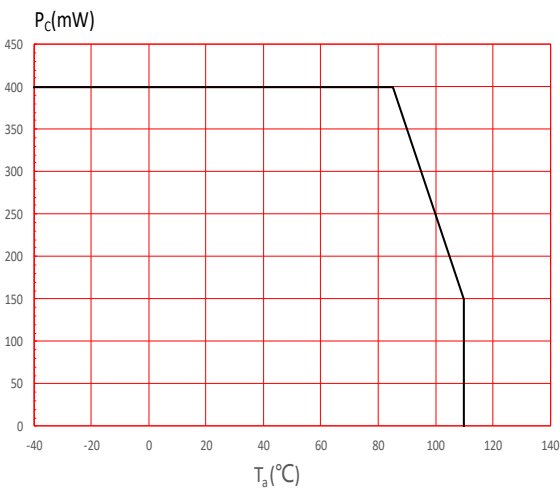


FIG.4: Threshold Input Current vs. Ambient Temperature

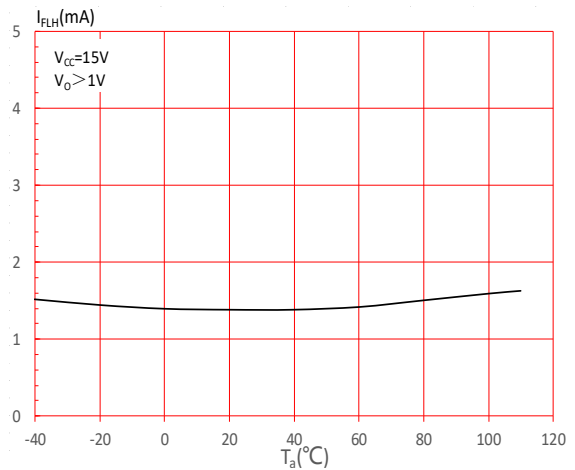


FIG.5: Low-level Supply Current vs. Ambient Temperature

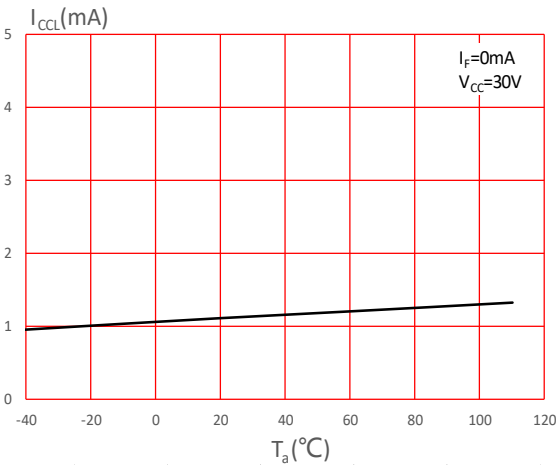
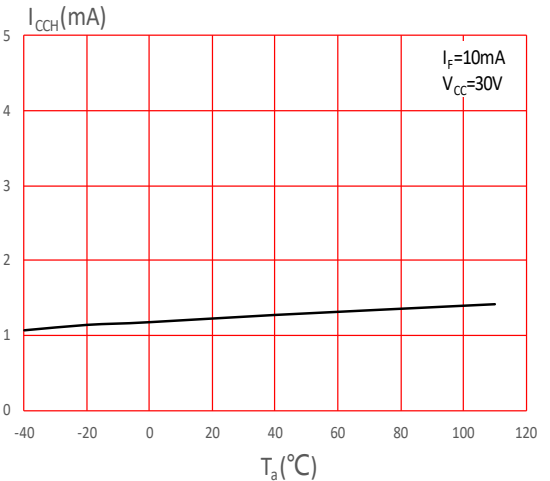
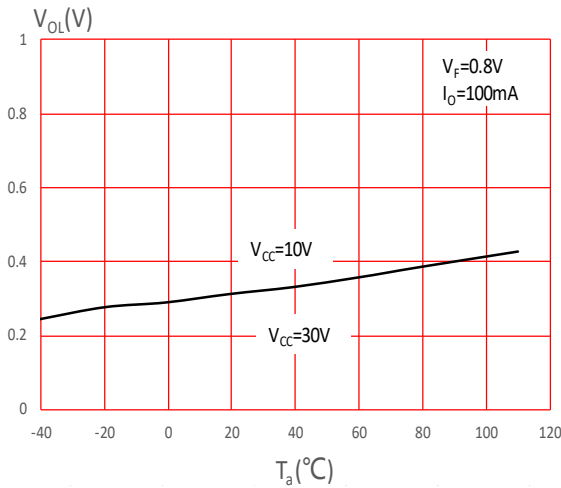


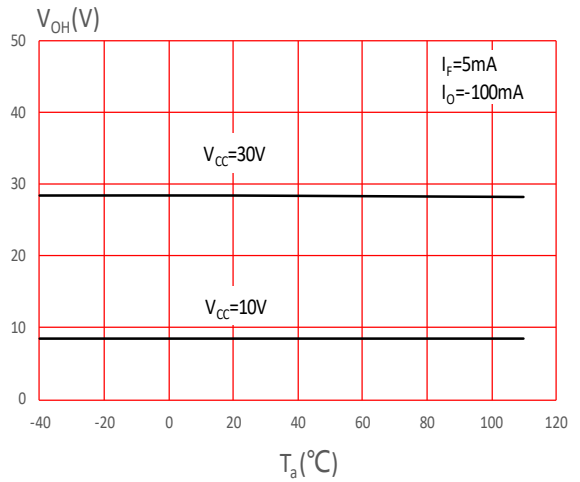
FIG.6: High-level Supply Current vs. Ambient Temperature



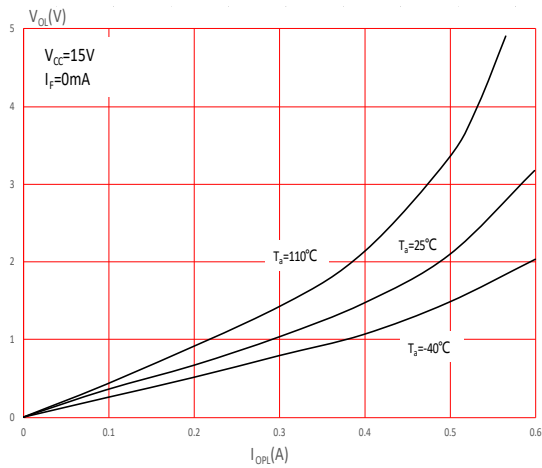
**FIG.7:** Low-level Output Voltage vs. Ambient Temperature



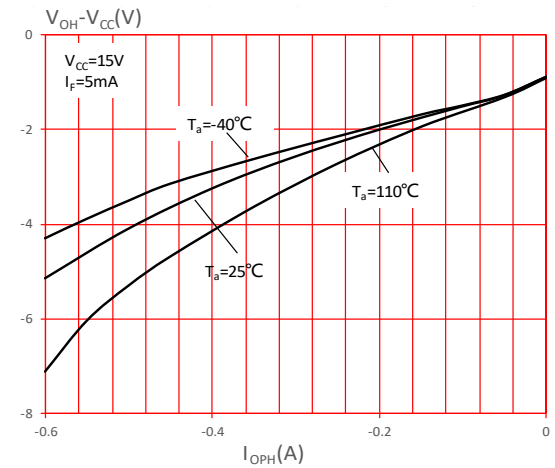
**FIG.8:** High-level Output Voltage vs. Ambient Temperature



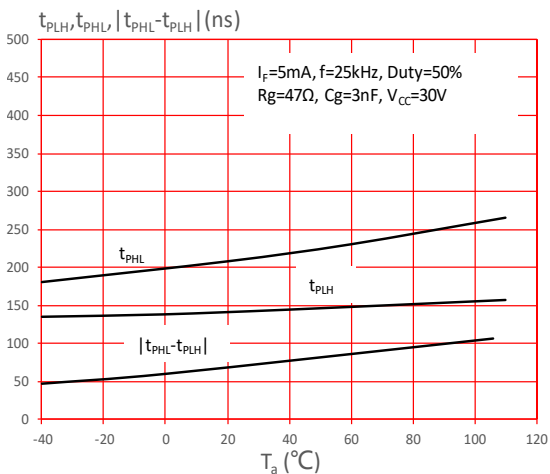
**FIG.9:** Low-level Output Voltage vs. Peak Low-level Output Current



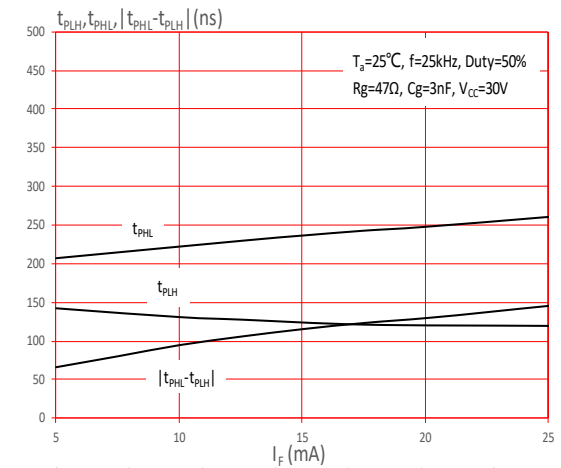
**FIG.10:** High-level Output Voltage Drop vs. Peak High-level Output Current



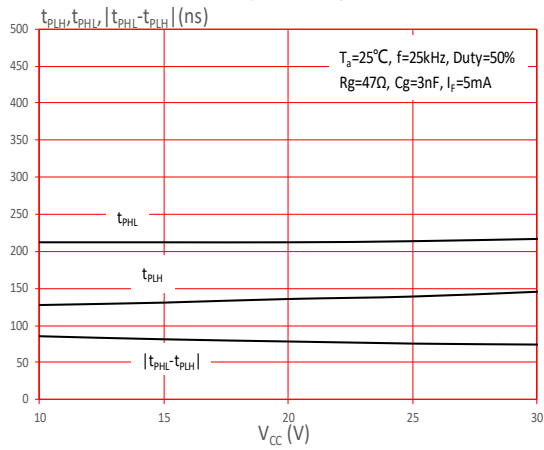
**FIG.11:** Propagation Delay Time, Pulse Width Distortion vs. Ambient Temperature



**FIG.12:** Propagation Delay Time, Pulse Width Distortion vs. Forward Current

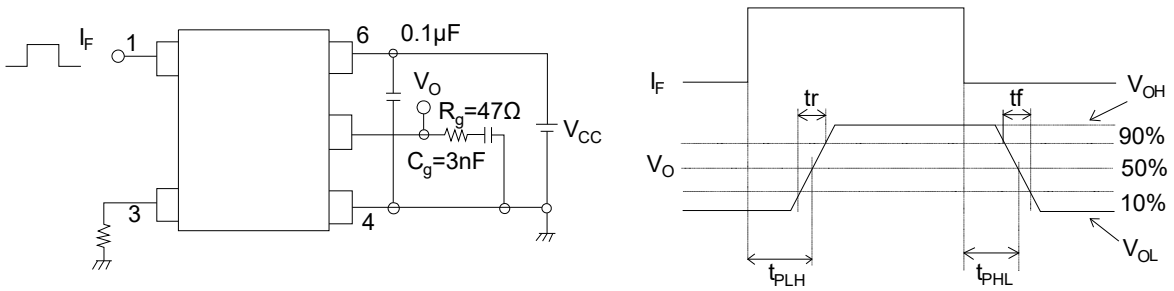


**FIG.13:** Propagation Delay Time,Pulse Width Distortion vs. Supply Voltage

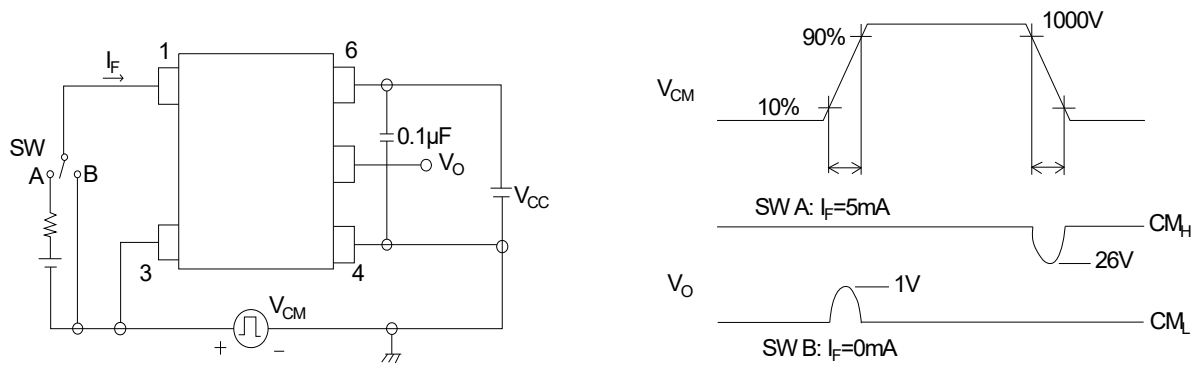


**Test Circuits**

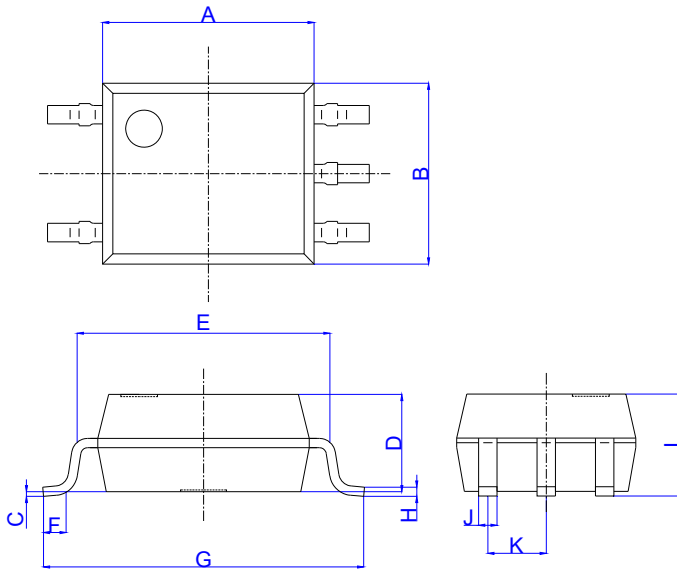
**FIG.14:** Switching Time Test Circuit and Waveform



**FIG.15:** Common-Mode Transient Immunity Test Circuit and Waveform

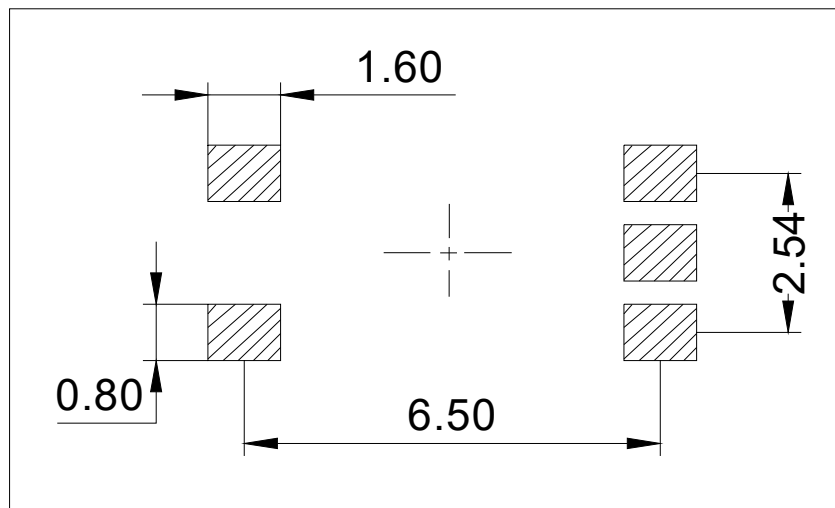


Package Dimension (Unit: mm)



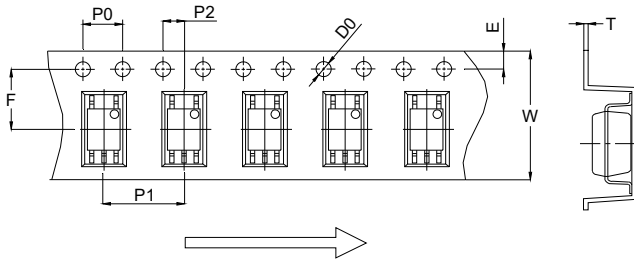
Ref.	Dimensions					
	Millimeters			Inches		
	Min.	Typ.	Max.	Min.	Typ.	Max.
A	4.40		4.80	0.173		0.189
B	3.60		4.20	0.142		0.165
C	0.00		0.20	0.000		0.008
D	1.90		2.30	0.075		0.091
E	5.00		5.60	0.197		0.220
F	0.34		0.94	0.013		0.037
G	6.70		7.30	0.264		0.287
H	0.10		0.30	0.004		0.012
I	2.00		2.40	0.079		0.094
J	0.25		0.55	0.010		0.022
K	1.02		1.52	0.040		0.060

RECOMMENDED SOLDER MASK (Dimensions in mm unless otherwise stated)



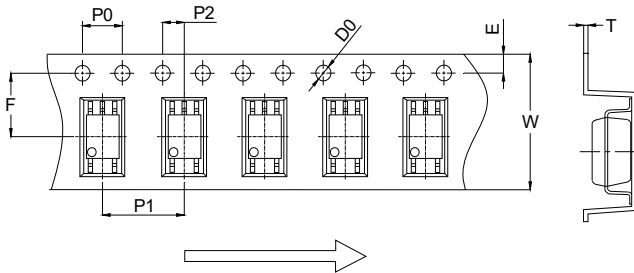
**CARRIER TAPE SPECIFICATIONS (Dimensions in mm unless otherwise stated)**

**Option None**



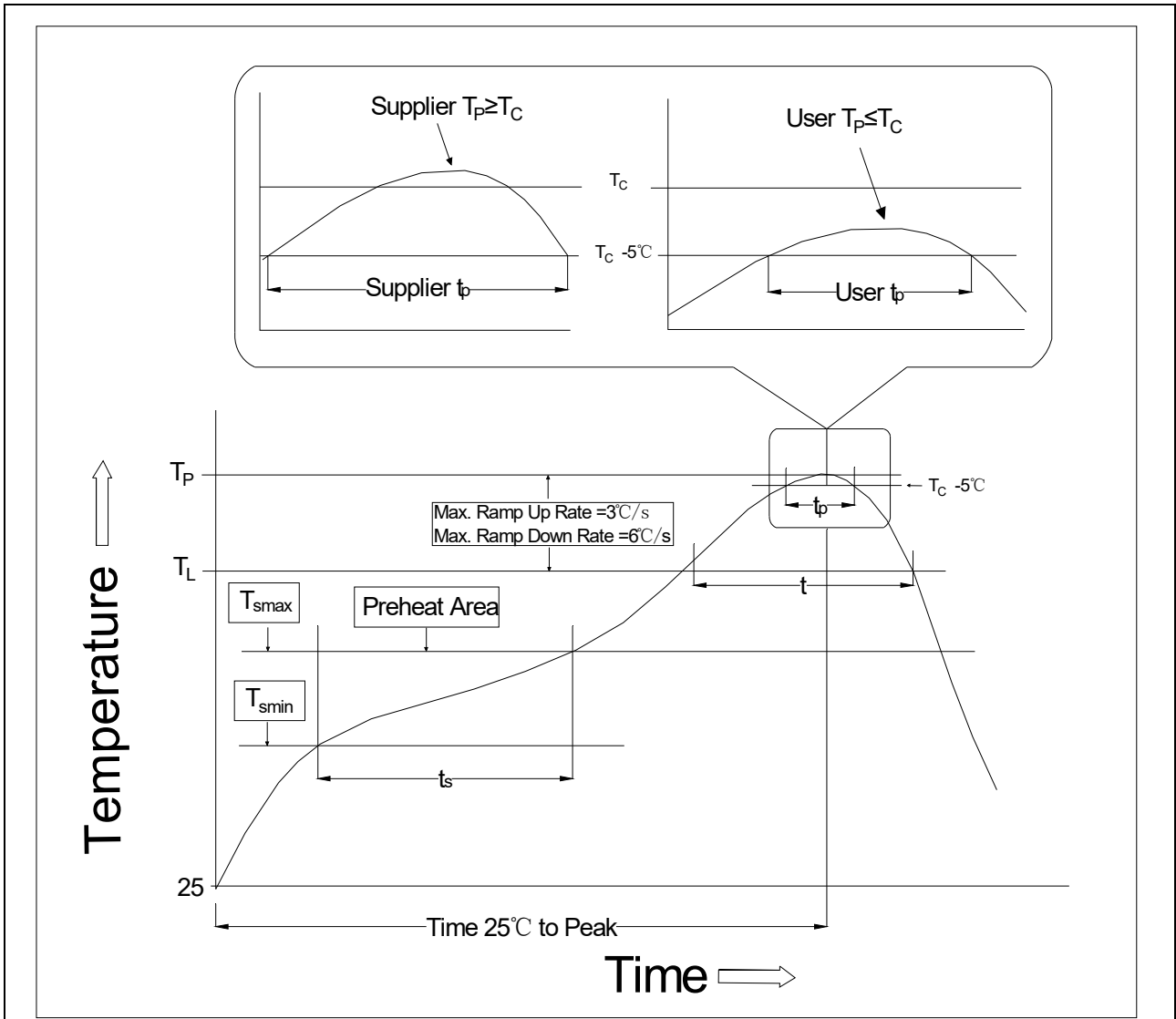
Ref.	Dimensions					
	Millimeters			Inches		
	Min.	Typ.	Max.	Min.	Typ.	Max.
D0		1.50	1.60		0.059	0.063
P0	3.90	4.00	4.10	0.154	0.157	0.161
P1	7.90	8.00	8.10	0.311	0.315	0.319
P2	1.90	2.00	2.10	0.075	0.079	0.083
E	1.65	1.75	1.85	0.065	0.069	0.073
F	4.40	4.50	4.60	0.173	0.177	0.181
T	0.25	0.30	0.35	0.010	0.012	0.014
W	11.90	12.00	12.30	0.469	0.472	0.484

**Option R**



Ref.	Dimensions					
	Millimeters			Inches		
	Min.	Typ.	Max.	Min.	Typ.	Max.
D0		1.50	1.60		0.059	0.063
P0	3.90	4.00	4.10	0.154	0.157	0.161
P1	7.90	8.00	8.10	0.311	0.315	0.319
P2	1.90	2.00	2.10	0.075	0.079	0.083
E	1.65	1.75	1.85	0.065	0.069	0.073
F	4.40	4.50	4.60	0.173	0.177	0.181
T	0.25	0.30	0.35	0.010	0.012	0.014
W	11.90	12.00	12.30	0.469	0.472	0.484

**REFLOW INFORMATION**




Profile Feature	Sn-Pb Assembly Profile	Pb-Free Assembly Profile
Temperature Min. (T <sub>smin</sub> )	100	150°C
Temperature Max. (T <sub>smax</sub> )	150	200°C
Time (t <sub>s</sub> ) from (T <sub>smin</sub> to T <sub>smax</sub> )	60-120 seconds	60-120 seconds
Ramp-up Rate (t <sub>L</sub> to t <sub>P</sub> )	3°C/second max.	3°C/second max.
Liquidus Temperature (T <sub>L</sub> )	183°C	217°C
Time (t <sub>L</sub> ) Maintained Above (T <sub>L</sub> )	60-150 seconds	60-150 seconds
Peak Body Package Temperature	235°C+0°C/-5°C	260°C+0°C/-5°C
Time (t <sub>P</sub> ) within 5°C of 260°C	20 seconds	30 seconds
Ramp-down Rate (T <sub>P</sub> to T <sub>L</sub> )	6°C/second max.	6°C/second max.
Time 25°C to Peak Temperature	6 minutes max.	8 minutes max.

Note:

1. Reflow soldering is recommended at the temperatures and times shown, no more than three times.
2. Avoid direct contact between the epoxy body and any tools or surfaces exceeding its maximum storage temperature.
3. Application of pressure on the epoxy body is prohibited at elevated temperatures. In specific scenarios, any applied force must not exceed 2.5N.
4. Ensure the component has cooled to ambient temperature before proceeding with any subsequent manufacturing steps.
5. The component has a shelf life of one year when stored under standard conditions.
6. Recommend storage Temp.: 0~40°C;  
Recommend storage humidity: <60%;  
MSL level: MSL 1

Information furnished in this document is believed to be accurate and reliable. However, Jiangsu JieJie Microelectronics Co., Ltd. assumes no responsibility for the consequences of use without consideration for such information nor use beyond it. Information mentioned in this document is subject to change without notice, apart from that when an agreement is signed, Jiangsu JieJie complies with the agreement.

Products and information provided in this document have no infringement of patents. Jiangsu JieJie assumes no responsibility for any infringement of other rights of third parties which may result from the use of such products and information. This document supersedes and replaces all information previously supplied.

 is a registered trademark of Jiangsu JieJie Microelectronics Co., Ltd.

Copyright © 2026 Jiangsu JieJie Microelectronics Co., Ltd. All rights reserved.