

JOR212D6 Series

Photo Relay

Description

The JOR212D6 Photo relay consist of a photo MOSFET、Photovoltage generator、infrared LED.

Features

- Normally opened (SPST)
- Load voltage: 60V
- Load current: 2A
- High sensitivity and Low on-resistance
- Controls low-level analog signal
- Low-level off state leakage current
- High isolation voltage between input and output (VISO=5000 Vrms)
- Lead free, meet RoHS standards

SCHEMATIC

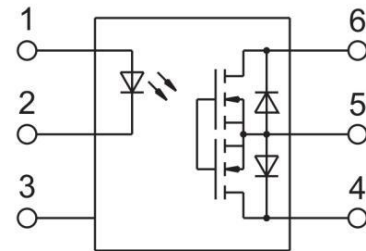

PIN DEFINITION

1. Anode
2. Cathode
3. NC
4. Drain
5. Source

PACKAGE OUTLINE

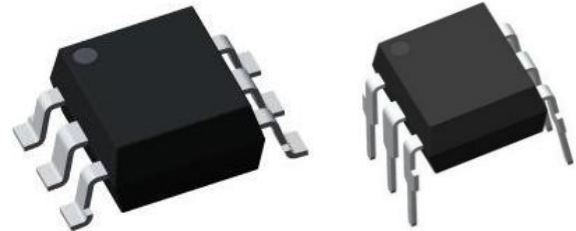

Applications

- Communications products (Personal computers, Laptops)
- Modem/Sensor
- Mobile phones/Security equipment
- Plant automation equipment
- Measuring instruments
- High-speed inspection machines

ORDERING AND MARKING INFORMATION

MARKING INFORMATION

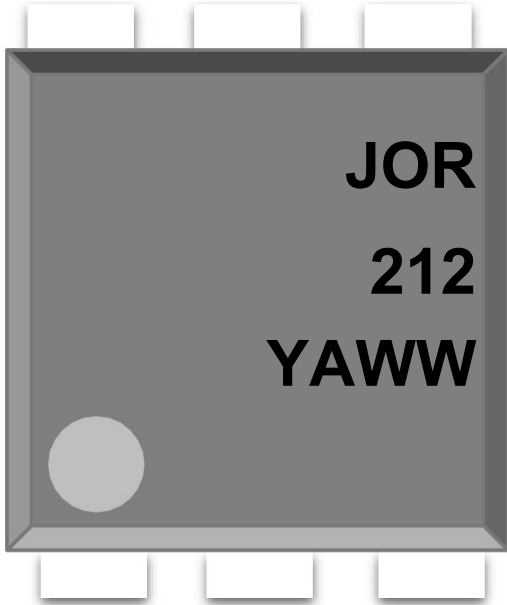

JOR : Company Abbr.
212 : Part Number
YAWW : LOT NO.

ORDERING INFORMATION

JOR212DX(Y)(Z)-G

JOR – Company Abbr
212 – Part Number
D – DIP or SMD Package
X – 6(Pin Count)
Y – Lead Form Option (SL/None)
Z – Tape and Reel Option (T1/T2)
G – Green

LABEL INFORMATION



Insulation and Safety related specifications

Item	Symbol	Value	Unit	Remark
Creepage Distance	L	7.0	mm	Measured from input terminals to output terminals, shortest distance path along body.
Clearance Distance	L	7.0	mm	Measured from input terminals to output terminals, shortest distance through air.
Insulation Thickness	DTI	0.4	mm	Insulation thickness between emitter and detector.
Peak Isolation Voltage	V _{IORM}	1500	V _{peak}	DIN/EN/IEC EN60747-5-5.
Transient Isolation Voltage	V _{IOTM}	7000	V _{peak}	DIN/EN/IEC EN60747-5-5.
Isolation Voltage	V _{ISO}	5000	V _{rms}	For 1 minute.

Absolute Maximum Ratings (T_A=25°C)

Parameter		Symbol	Rating	Unit	
Input	LED Forward Current	I _F	50	mA	
	LED Reverse Voltage	V _R	3	V	
	Peak Forward Current	I _{FP}	1	A	
	Power Dissipation	P _{in}	75	mW	
Output	Load Voltage (Peak AC)	V _L	60	V	
	Continuous Load Current	I _L	A	2	A
			B	3	
			C	4	
	Peak Load Current	I _{peak}	6	A	
Power Dissipation	P _{out}	600	mW		
Total Power Dissipation		P _{tot}	650	mW	
Isolation Voltage		V _{ISO}	5000	V _{rms}	
Operating Temperature		T _{opr}	-40~+85	°C	
Storage Temperature		T _{stg}	-40~+100	°C	
Soldering Temperature		T _{sol}	260	°C	

Electro-optical Characteristics (T_A=25°C)

Parameter		Symbol	Condition	Min.	Typ.	Max.	Unit
Input	LED Operate Current	I _{Fon}	I _L =2A	-	1	3	mA
	LED Turn Off Current	I _{Foff}	I _L =2A	0.1	0.6	-	mA
	LED Dropout Voltage	V _F	I _F =5mA	1	1.3	1.4	V
Output	On Resistance	R _{on}	I _F =5mA I _L =2A within 1s on time	-	0.6	1.5	Ω
	Off State Leakage Current	I _{Leak}	I _F =0mA V _L =60V	-	-	1000	nA
Transfer Characteristics	Turn On Time	T _{on}	I _F =5mA I _L =2A	-	2.4	5	ms
	Turn Off Time	T _{off}	I _F =5mA I _L =2A	-	0.5	1	ms
	I/O Capacitance	C _{ISO}	f = 1 MHz V _B =0V	-	0.8	1.5	pF
	Initial I/O Isolation Resistance	R _{ISO}	500 V DC	1000	-	-	MΩ

Fig.1 LED Dropout Voltage vs. Ambient Temperature

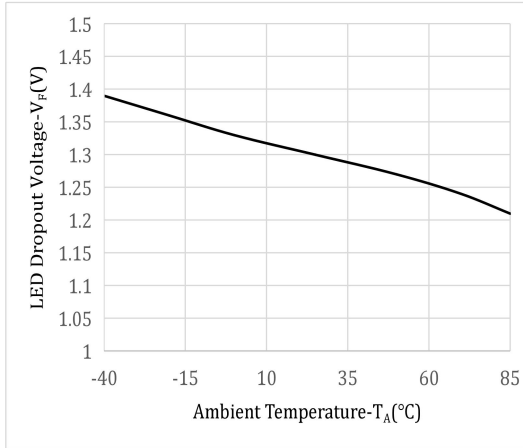

Fig.2 Output Current vs. Output Voltage

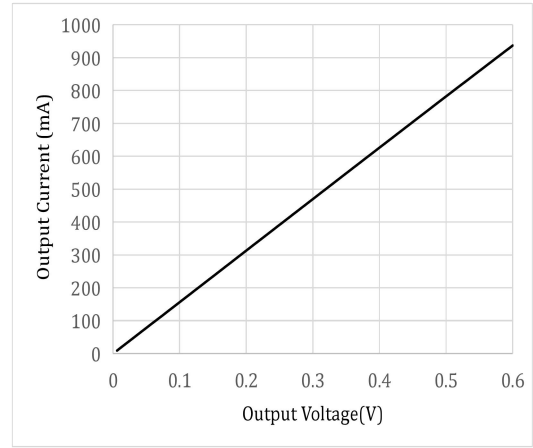

Fig.3 On Resistance vs. Ambient Temperature

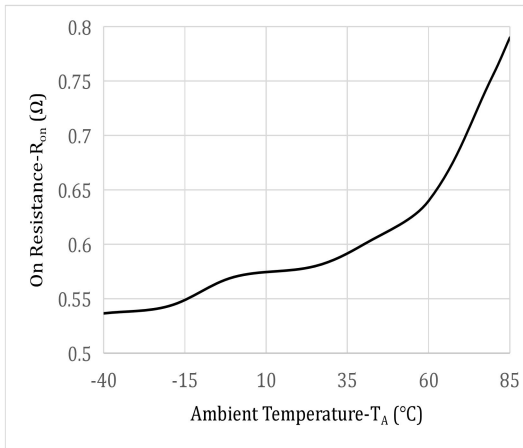

Fig.4 Load Current vs. Ambient Temperature

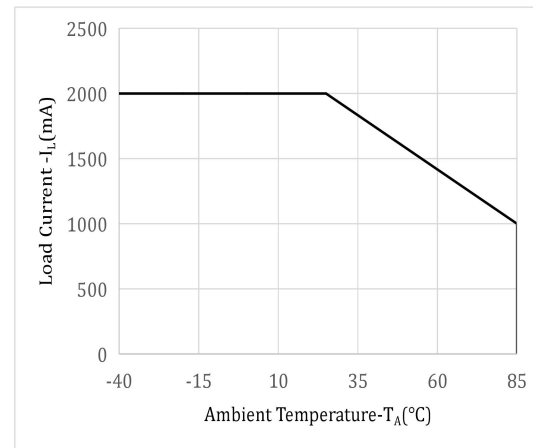

Fig.5 LED Operate Current vs. Ambient Temperature

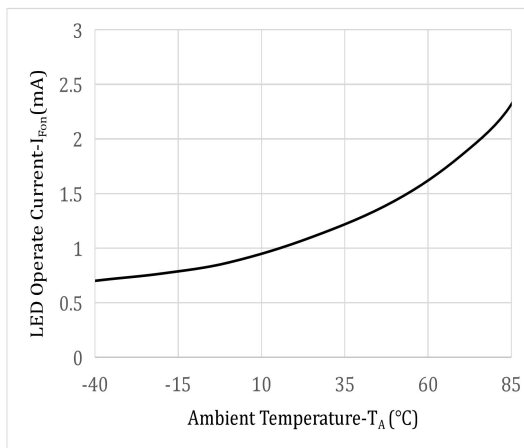

Fig.6 LED Turn Off Current vs. Ambient Temperature

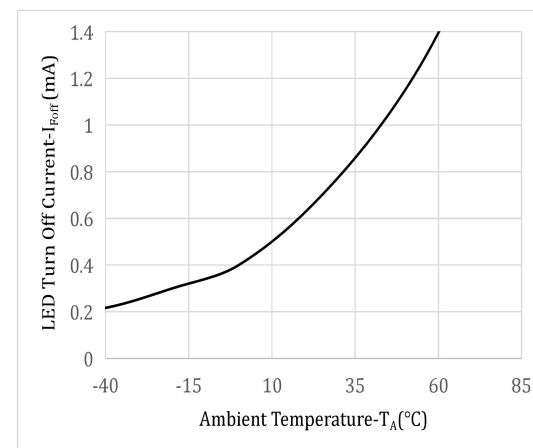

Fig.7 Turn On Time vs. Ambient Temperature

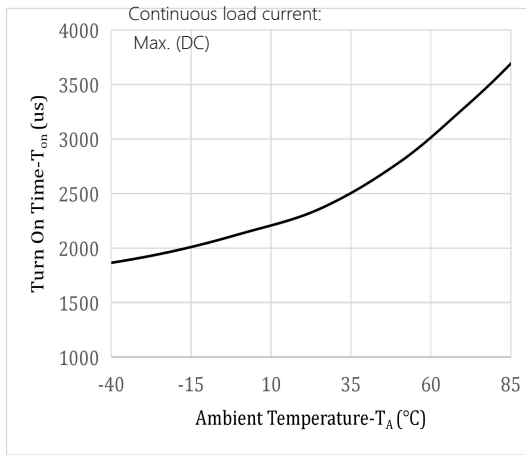

Fig.8 Turn Off Time vs. Ambient Temperature

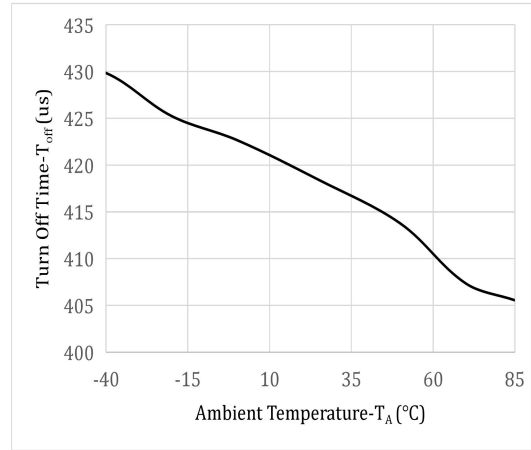

Fig.9 Turn On Time vs. LED Forward Current

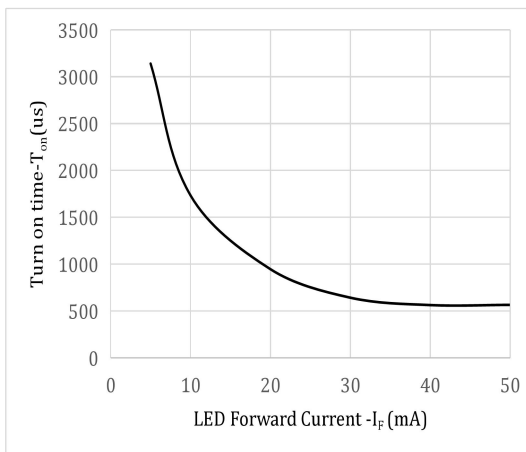

Fig.10 Turn Off Time vs. LED Forward Current

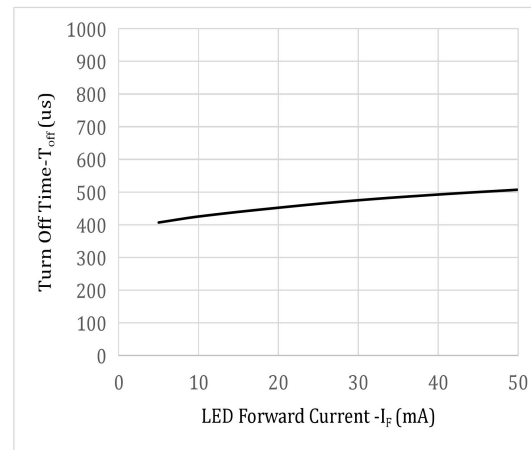
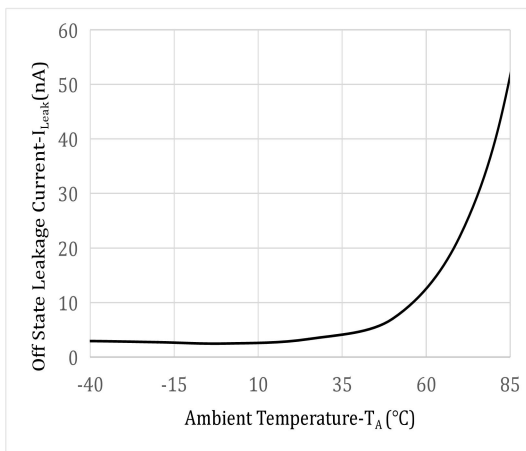

Fig.11 Off State Leakage Current vs Load Voltage



Outline Dimensions

Photo Relay

DIP6

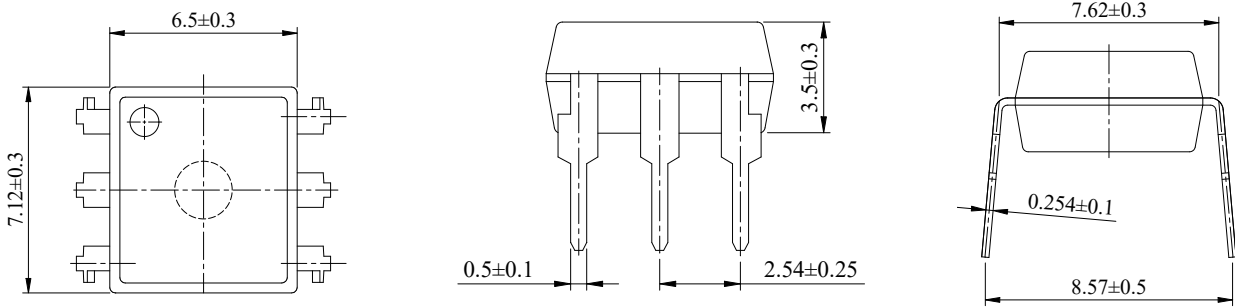

SMD6

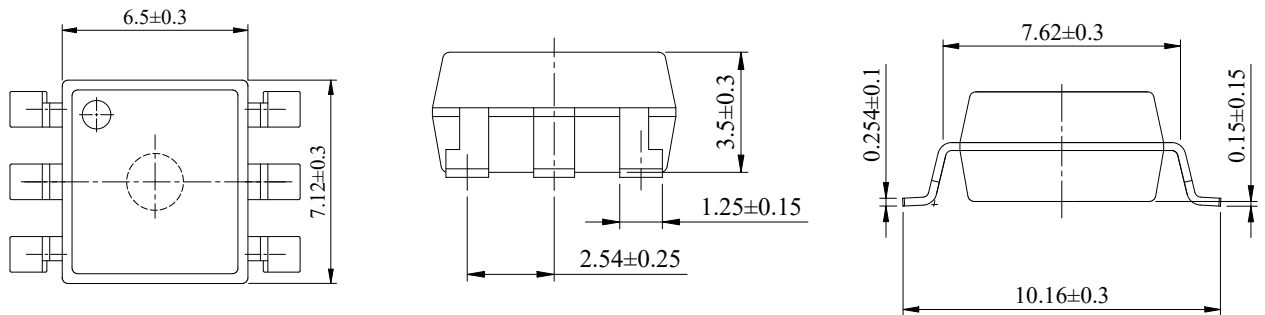

Unit: mm

Recommended Pad Layout

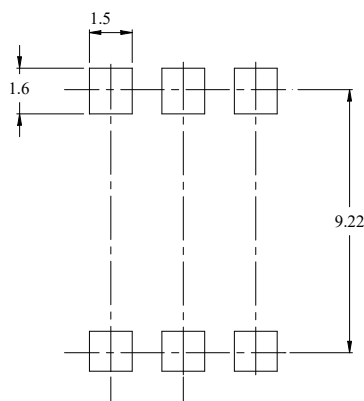

Unit: mm

Note: The picture above is the front view of the product.

Solder Reflow Profile

Photo Relay

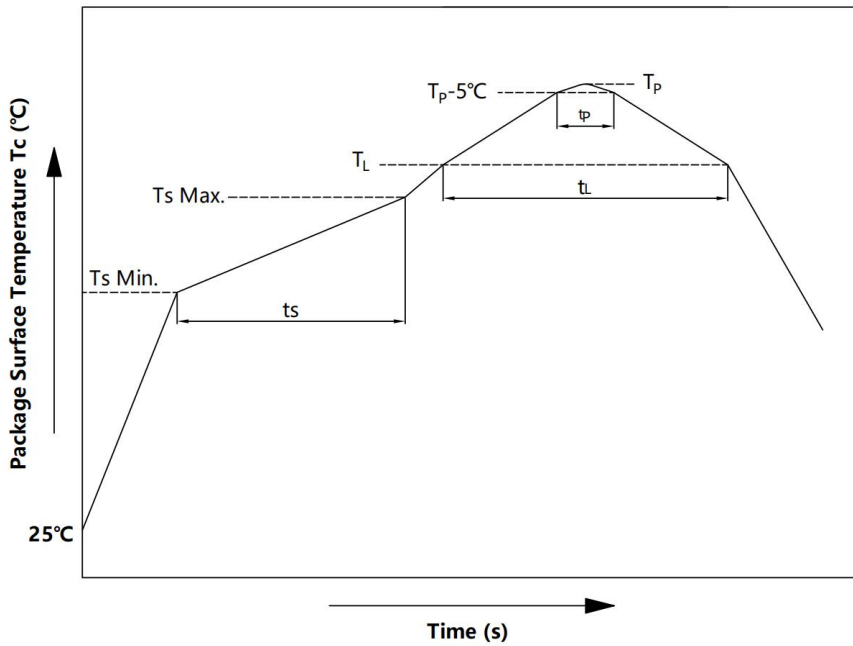

Item	Symbol	Min.	Max.	Unit
Preheat Temperature	T_S	150	200	°C
Preheat Time	T_S	60	120	s
Ramp-Up Rate (TL to TP)	-	-	3	°C/s
Liquidus Temperature	T_L	217		°C
Time Above TL	T_L	60	150	s
Peak Temperature	T_P	-	260	°C
Time During Which TC Is Between (TP-5) and TP	T_P	-	30	s
Ramp-down Rate (TP to TL)	-	-	6	°C/s

Note: Reflow soldering is recommended at the temperatures and times shown, no more than three times.

Wave Soldering Profile

Photo Relay

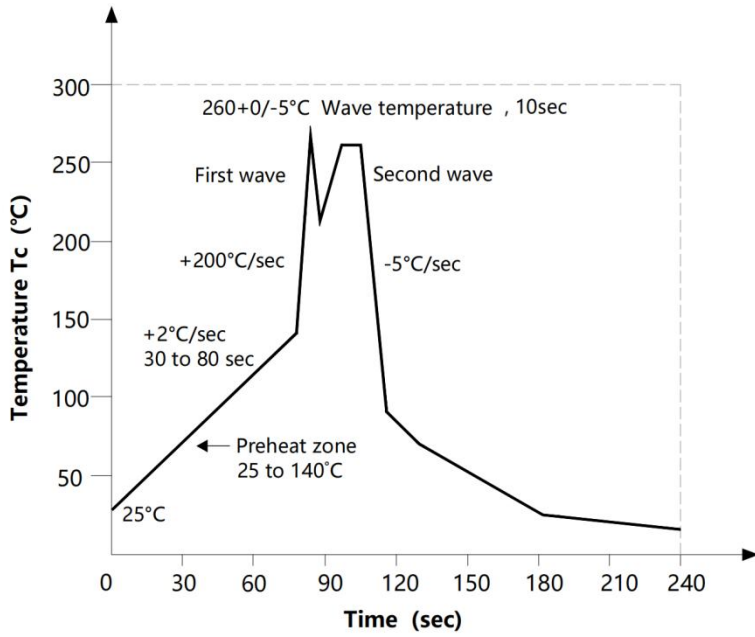

Soldering with hand soldering iron

- A. Hand soldering iron is only used for product rework or sample testing;
- B. Manual soldering method Temperature: 360°C ± 5°C , within 3s.

Packing

Photo Relay

Summary table

Package Type	Packing Form	Quantity per Reel	Quantity per Box	Quantity per Carton	Antistatic Bag Specification	Box Specification	Carton Specification	Note
SMD6	Reel (ϕ 330mm Blue)	1k pcs/reel	2 reels /box	10 boxes /ctn	380*380mm	340*60*340 mm	620*360*365mm	Leave at least 200mm of blank space at both ends
DIP6	Tube (500*12*11mm)	65 pcs/tube	50 tubes/box	10 boxes/ctn	Not applicable	525*128*56 mm	535*275*300mm	Use blue and white rubber stoppers for each tube, with the same direction

DIP6 Tube

- 1) Qty/tube: 65 pcs.
- 2) Qty/ctn: 32500 pcs.
- 3) Inner packing: 50 tubes/box.
- 4) Schematic:

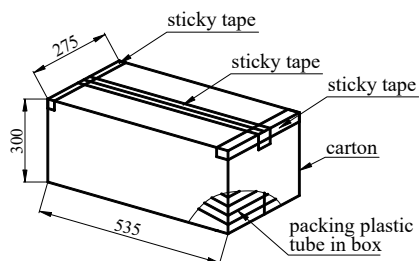

SMD6 Tape & Reel

- 5) Qty/reel: 2000 pcs.
- 6) Qty/ctn: 40000 pcs.
- 7) Inner packing: 2 reels/box.
- 8) Schematic:

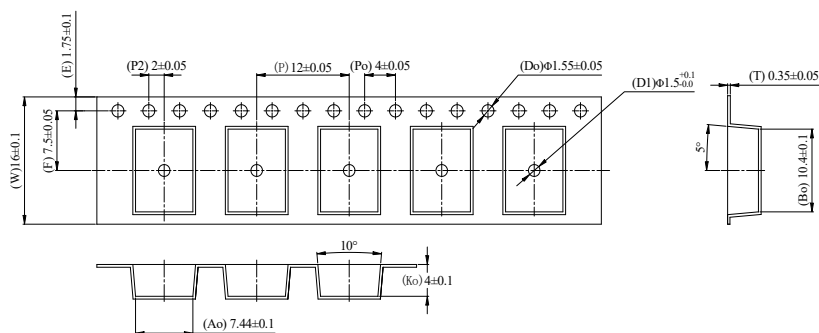

Unit: mm